

# *National* **RADIO-TV NEWS**



Dec.-Jan.  
1953-1954

**IN THIS ISSUE**  
Hum Problems in TV Receivers  
Using Diagrams in Set Servicing  
Alumni Association News

VOL. 15  
No. 12



A SPECIAL MESSAGE  
FOR RELIGION IN  
AMERICAN LIFE  
BY  
PRESIDENT  
DWIGHT D. EISENHOWER

THE early American settlers were hardy and courageous and resourceful. They had to be—else none of them would have survived. But they were not sufficient unto themselves. The odds they were up against—facing that hostile wilderness—were too great for them to rely on themselves alone. They needed God's help; they gladly sought it and they frankly acknowledged that it was that Power beyond themselves that provided the strength which saw them through.

I believe there are many indications in American life today that that faith is reviving. Faced as we are with difficult times, confronted with much uncertainty, we are beginning to recognize that we are no more self-sufficient than our forbears were. More frankly perhaps than in less disturbed times, we are beginning to acknowledge that, like them, we need God's help.

That, I believe, is why our churches today are more crowded; why religion is more frequently talked about; why faith seems, more and more, to be something men and women and young people frankly try to live by.

One of the undertakings dedicated to such revival of faith is the non-sectarian movement known as Religion In American Life. This movement calls our attention to our religious institutions and their essential place in the life of every one of us. I am happy to have a part in that undertaking.

I should like to feel that, in every American family, some place is made for an expression of our gratitude to Almighty God, and for a frank acknowledgement of our faith that He can supply that additional strength which, for these trying times, is so sorely needed.

# HUM PROBLEMS

## IN

# TV RECEIVERS

*Reprinted from the DU MONT SERVICE NEWS, a publication of Allen B. Du Mont Laboratories, Inc.*

THERE are two common sources of hum in a TV receiver, the 60-cycle filament supply, and the 120-cycle ripple present in the output of the low-voltage rectifier. The symptoms produced by hum depend upon which source is involved, the stage or stages into which the hum is fed, and its amplitude.

Attempting to locate the source of a hum condition without the ability to analyze the symptoms exhibited in the picture and sound can be a confusing and difficult task. Familiarity with the various hum symptoms will make it relatively easy to pin-point the fault.

### Picture Symptoms

The picture furnishes a great deal of information with regard to the cause of hum. One or more of the following symptoms may be observed in the picture.

One or two broad bars in the picture caused by variation in brightness.

A single broad bar in the *raster*. This will always be accompanied by a similar condition in the picture, although one or two bars may appear in the picture and not affect the *raster*.

A sinusoidal ripple at the horizontal edges of the picture. This ripple may appear in any one of several forms.

A sinusoidal ripple at the horizontal edges of the *raster*. This symptom will always be accompanied by a similar ripple in the picture, although a ripple may appear at the edges of the picture but not the *raster*.

Poor sync stability.

Loss of vertical and/or horizontal sync.

*Ed. Note:* The author of this article refers to the left and right edges of the raster, or picture, as the "horizontal edges." This may be new terminology to some of our readers.

### Sound Symptoms

In the sound output of a receiver hum results in a 60-cycle or 120-cycle audio tone. With a little experience it is possible to distinguish between 60-cycle or 120-cycle hum.

Hum should not be confused with sync buzz. Sync buzz is caused by the incoming sync or the vertical sweep signals. Sync buzz can be distinguished from hum by its sound. Since sync buzz is due to pulse-type signals it contains numerous high-frequency components which give it a sharp raspy sound; while hum, being the result of a sine-wave signal, is smooth sounding and comparatively unobtrusive to the ear.

If you are in doubt, sync buzz can be identified as follows: short out the antenna terminals of the receiver, if the tone disappears it is probably sync buzz due to the incoming sync signal. If it persists, vary the setting of the vertical hold control. If the tone varies with the setting of the hold control the tone is probably buzz due to the vertical sweep signal. If the tone remains constant it is probably due to a hum condition.

### Locating the Hum Source

As with most other faults, the first step in troubleshooting is careful analysis of the picture and sound.

Determine whether the hum is of the 60-cycle or 120-cycle variety. If the hum is present in the sound and not the picture you will have to de-

*Please Note.* Any correspondence to the Allen B. Du Mont Laboratories concerning this article should be addressed to: Teleset Service Department, 257 Sixteenth Avenue, Paterson, New Jersey.

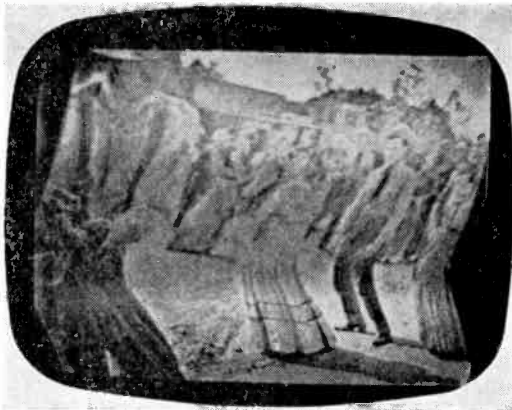

Fig. 1—60 cycle hum. Note the variation in brightness, which produces a horizontal bar in the picture. The hum also causes the ripple visible at the edge of the picture. The size has been reduced to show the edges of the picture.

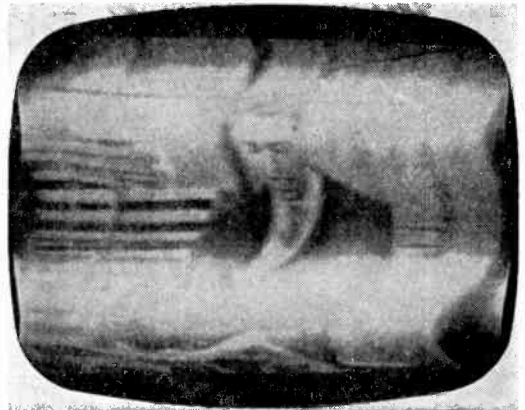

Fig. 2—120 cycle hum. The two horizontal bars and sinusoidal ripples at the sides of the picture are characteristic of 120 cycle hum.

termine its frequency from past experience.

If another receiver is available, 60-cycle hum can be produced by connecting a 1-megohm resistor from the heater to the grid of the audio amplifier. The hum produced may then be compared with that in the output of the receiver under test to determine the hum frequency.

If 60-cycle hum is present in the sound and not in the picture, the fault is probably in a sound i-f, sound detector or an audio-amplifier stage. Since heater-cathode leakage is the most common cause of 60-cycle hum check the tubes in these stages first.

The appearance of 60-cycle and 120-cycle hum

in the picture is shown in figures 1 and 2. Note that 60-cycle hum produces one cycle of brightness variation from the top to the bottom of the picture, and a single ripple at the picture and/or raster edges. 120-cycle hum produces two "hum bars" and two sinusoidal ripples at the picture and/or raster edges.

If the receiver is suffering from loss of sync, adjust the controls to obtain momentary sync and examine the picture for hum symptoms. When the trouble is due to hum this can be accomplished without difficulty, except in the most severe cases.

120-cycle hum is almost always due to failure of a low-voltage, power-supply filter component. It usually appears in the sound and picture simultaneously. A check of the filter capacitors,

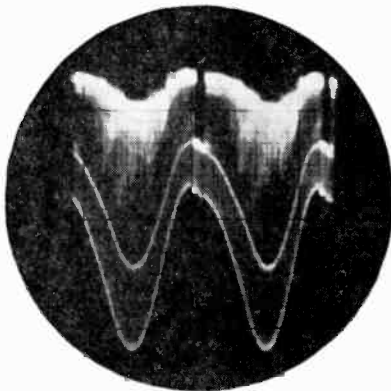
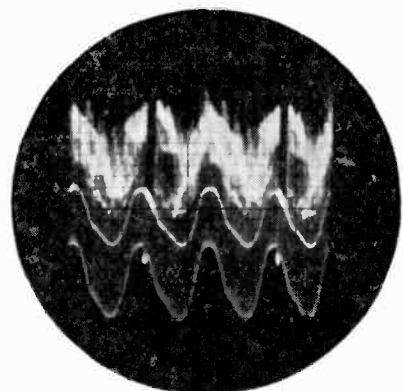

Fig. 3—Composite video signal with hum superimposed. For purposes of illustration a more severe condition  
Page Four



than that usually encountered is shown. Left—60 cycle hum, Right—120 cycle hum.



Fig. 4—60 cycle hum in a stage following the sync take-off causes a hum bar but does not affect the edges of the picture.

by bridging them with a good unit will usually turn up the fault.

It might be well to note at this point that the references made here to 120-cycle hum apply to Du Mont receivers, and others which use full-wave rectification in their low-voltage power supplies. Some receivers may be encountered which employ half-wave rectifiers. In this case the power-supply ripple will be 60-cycle and the indications produced by a faulty filter component will be those shown in figure 1. In the discussion which follows it is assumed that the receiver uses a full-wave low-voltage power supply.

When the picture exhibits a single hum bar and a single sinusoidal bend it indicates that 60-cycle voltage is entering one of the stages preceding the sync takeoff. The most common source of this difficulty is heater-cathode leakage in one of the tubes through which the signal passes. Check the rf, mixer, oscillator, video i-f, video detector and other tubes preceding the sync takeoff by substitution. The mixer, oscillator and r-f amplifier tubes are the most common offenders since the signal is at a very low level in these stages.

If the above fails to remedy the difficulty examine the waveform at the grid and plate of each stage with an oscillograph. The appearance of the composite video signal with 60-cycle hum superimposed on it is shown in figure 3. The faulty stage is the earliest one in whose output the hum is present.

If a hum bar appears in the picture but the horizontal edges of the picture are normal, as shown in figure 4, the difficulty is probably in a video detector or video amplifier stage, fol-

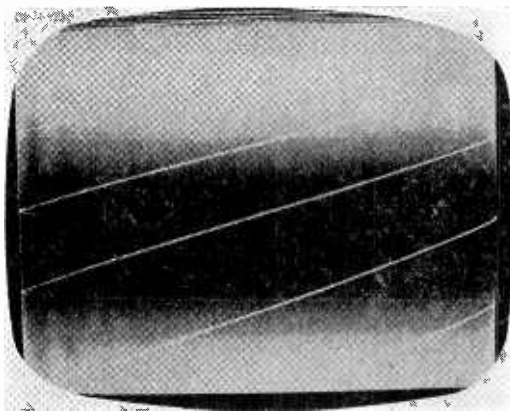

Fig. 5—Hum bar in raster. This condition is usually due to heater-cathode leakage in the video amplifier or CRT.

lowing the sync takeoff. In some cases, when the hum is comparatively low amplitude, this symptom may occur as a result of heater-cathode leakage in an i-f or tuner tube. In this case the hum is strong enough to affect the picture but does not get through the sync circuits. Tuning to an unused channel and shorting out the antenna terminals of the receiver will give an indication as to the location of the fault. If the hum is visible in the raster, as shown in Figure 5, and is not greatly reduced when the antenna terminals are shorted, the hum is probably occurring in a stage following the video detector. Check the tubes and components in the video amplifier. Don't overlook the possibility of heater-cathode leakage in the CRT.

To determine whether the hum is due to the CRT or an earlier stage, remove the last video-amplifier tube. If the hum persists the fault is probably due to heater-cathode leakage in the CRT, or a short in the heater-cathode circuit wiring.

If the picture has a sinusoidal bend, but the raster is OK and there is no hum bar, as shown in figure 6, the trouble is probably in the horizontal sync or a-f-c circuits. Check tubes by substitution. If this fails to turn up the fault examine the wiring for shorts between grid and filament, or cathode and filament, circuits.

If a 60-cycle ripple is present at the horizontal edges of the raster, but a hum bar does not appear in the picture, as shown in figure 7, check the horizontal-sweep circuits. Note the reference to the raster. Hum in the horizontal oscillator or horizontal-sweep amplifier circuits will produce a ripple on the horizontal edges of the raster itself. This of course is accompanied by



Fig. 6—A single ripple in picture, with straight raster edges and no hum bar indicates hum in the horizontal sync or a-f-c circuits.

a ripple in the picture. Hum in a stage preceding the sweep circuits usually does not affect the raster edges. In a few cases it is possible for hum, occurring in the a-f-c circuits, or another stage preceding the sweep circuits, to reach the sweep circuits and cause raster distortion. This condition can usually be recognized by the fact that the amplitude of the ripple in the raster is much less than the amplitude of the picture ripple.

There is one final point to keep in mind. The exact symptoms which hum produces in the pic-



Fig. 7—A single sinusoidal ripple at the edges of the raster, in the absence of a hum bar, indicates that 60-cycle hum is being introduced in the horizontal sweep circuits.

ture or raster depend upon the design of the particular receiver involved, and the amplitude of the hum. In severe cases hum produced by a fault in one stage may reach other stages via the B+ or a-g-c circuits. Under such conditions be guided by the most pronounced symptoms. The hum can often be isolated to a particular portion of the receiver by removing tubes.

If the a-c power source for the receiver is not in phase with that of the station being received, hum bars will move through the picture and the ripple at the edges of the picture will vary.



## OUR COVER PHOTO

### WOND'ROUS NIGHT

*High upon our Christmas tree,  
A single shining star  
Sheds its light but modestly,  
Yet casts its warmth afar;  
Symbol of the Star—this gem—  
That gave its light to Three,  
That they might come to Bethlehem  
And worship joyfully.*

*'Neath the star that tops our tree  
Are shining silver things,  
Reindeer, birds and brilliancy,  
And color fit for kings.  
Hand in hand the youngsters stand  
Enchanted by the sight—  
Picture now this fairyland  
And keep this wond'rous night!*

JEANNE COLE

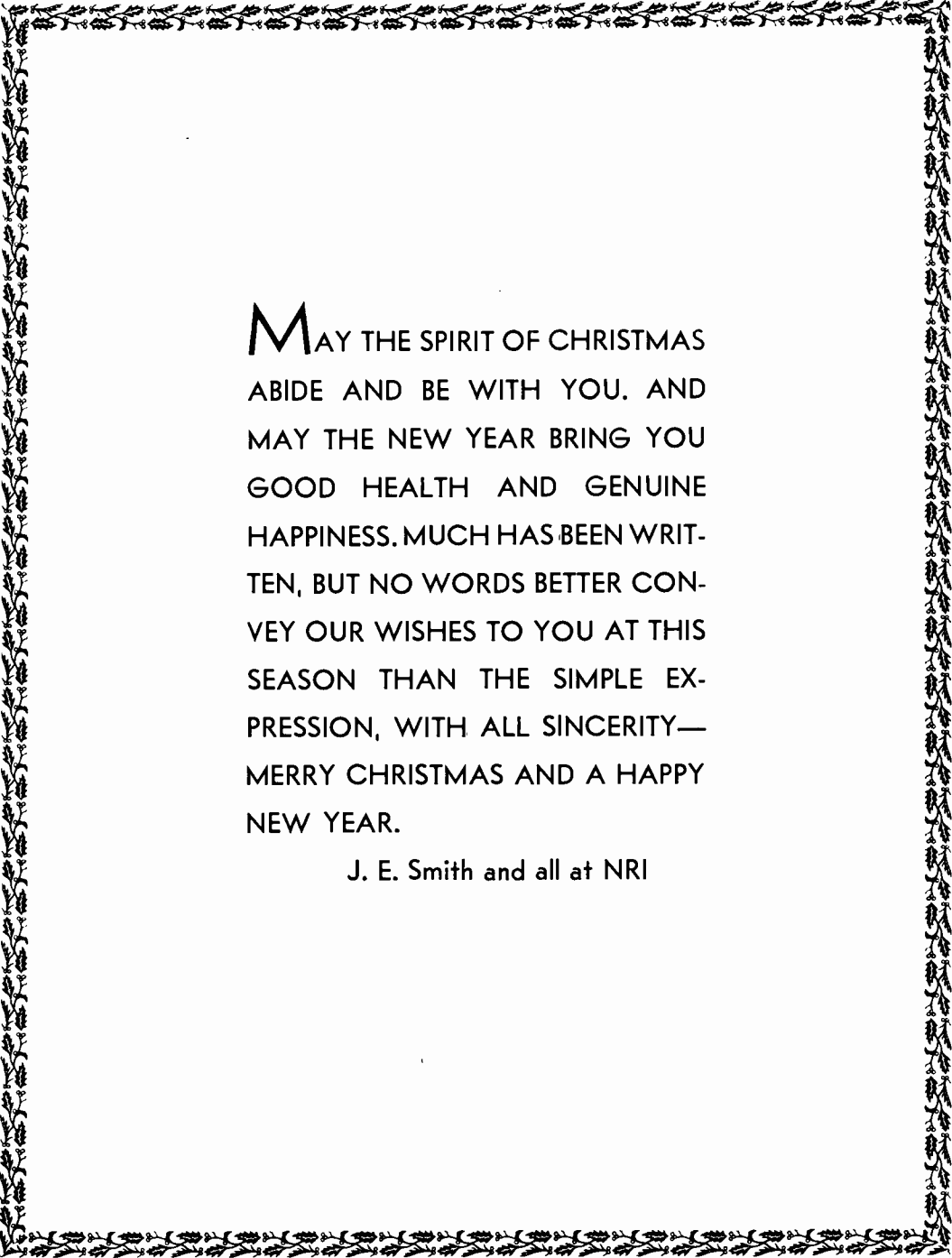

MAY THE SPIRIT OF CHRISTMAS  
ABIDE AND BE WITH YOU. AND  
MAY THE NEW YEAR BRING YOU  
GOOD HEALTH AND GENUINE  
HAPPINESS. MUCH HAS BEEN WRIT-  
TEN, BUT NO WORDS BETTER CON-  
VEY OUR WISHES TO YOU AT THIS  
SEASON THAN THE SIMPLE EX-  
PRESSION, WITH ALL SINCERITY—  
MERRY CHRISTMAS AND A HAPPY  
NEW YEAR.

J. E. Smith and all at NRI

# USING DIAGRAMS

IN

## SET SERVICING

By J. B. STRAUGHN

Technical Editor, National Radio-TV News



J. B. Straughn

**T**HIS article explains how to use diagrams in service work. It discusses the use of the schematic in spotting causes of part failure, in determining the tests which should be made on the suspected parts and in deciding on appropriate test connection points for your voltmeter or ohmmeter probes.

The article shows why you should study theory to learn how parts work individually and together in a circuit. It is excellent review material for the experienced serviceman and contains a wealth of information for the beginner.

The schematic and other illustrations appear as shown in the Philco factory manual for the model 53-559 receiver.

Fig. 1 shows the diagram of a typical receiver the circuits of which we will discuss. An analysis of the schematic indicates that the set is a superheterodyne since the 12BE6 is marked as being a converter stage while the 12BA6 is marked as being in an i-f amplifier stage. Such stages are only found in superheterodyne receivers.

The schematic shows that the receiver uses a 12AV6 as the second detector, AVC and first audio tube and that it uses a 35C5 power output tube. A 35W4 is used as a conventional half wave rectifier.

Due to the absence of a power transformer we can conclude that this is an ac-dc receiver, operating from either a 110 volt dc or a 110 volt ac source.

Page Eight

The operating voltages are marked on the schematic and since 123 volts is shown at the cathode (pin 7) of the rectifier we assume that these operating voltages were taken when the receiver was plugged into an ac power line. If plugged into a dc power line the cathode to B—voltage of the rectifier tube would have been considerably less than the line voltage.

A further examination of the schematic shows that the frequency range of the receiver may be changed by throwing the switches marked SWI in the rf and oscillator circuits. Both switches are mounted on the same shaft and are controlled by a single knob on the rear of the receiver. This particular receiver tunes not only the broadcast band but also the police band, covering from 1700 kc to 3400 kc.

The band change is made very easily, for when the switch in the oscillator circuit is thrown to the other position (to the contact marked 2) coil L2 is placed in parallel with the regular oscillator tank coil (T1), lowering the inductance in the oscillator circuit and causing it to tune to a higher frequency. In the same manner when the antenna switch is in position 2 the tuned circuit consisting of L1 and C21 is in parallel with the loop and tuning condenser thus making the grid circuit of the 12BE6 also tune to a higher frequency.

In looking at the schematic, locate the second i-f transformer between the 12BA6 tube and the 12AV6. Note the dotted lines which enclose the transformer as well as condensers C11 and C12. This means that these condensers are inside the



i-f transformer can and cannot be seen in the chassis.

The dotted line marked PC-1, enclosing the parts between the 12AV6 and 35C5, tubes show that the parts in question are on a printed circuit. In this case you will find a four lead, flat ceramic part, containing resistors R7 and R8 and condensers C14, C15 and C16.

A bottom view of this receiver is shown in Fig. 2. Here the connections between all of the parts and their tie points in the circuit are shown. This is not practical in a photograph. In most instances manufacturers do not go to such pains, being satisfied to show merely the relative physical position of the parts in the circuit. Note that the printed circuit discussed above is marked PC-1 on the chassis layout and that its leads are marked to correspond to the lead marking shown on the schematic. On the schematic note that lead 2 of PC-1 connects to terminal 7 of the 12AV6 type tube. Referring to the base layout you will see that this same connection is shown making the actual location of PC-1 easy. Note that lead 4 of PC-1 connects to terminal 6 of the 12AV6 type tube as does resistor R9. Terminal 3 of PC-1 connects to socket terminal 2 of the 35C5. Terminal 2 of the 35W4 socket does not connect to a tube electrode and is not shown in Fig. 1. This means that terminal 2 of this socket is used as a "tie" point—a convenient insulated mounting point. This is done frequently in radio work so be on the lookout for such connections—tube base layouts will prevent you from being fooled.

Lead 1 of PC1 connects to the red lead from condenser C18. Looking at schematic you can see that this must be section C18-c in the electrolytic condenser, even though the colors of the leads on the electrolytic do not appear on the schematic.

It will be well worth your while to spend a little time in practicing how to locate parts on the chassis layout from parts you find on the schematic. Some parts are located on the top of the chassis and these are shown in the top view in Fig. 3. Note that the band change switch is mounted on the back of the chassis and that coils L-1 and L-2 as well as condenser C-2 are mounted directly on the band switch.

Fig. 4 shows the alignment procedure as presented in the manufacturer's service information. Such complete instructions are not always available, but the advanced Lessons in the Servicing Course explain the alignment procedures to follow with any type of receiver.

The method of connecting the signal generator to the receiver is given, the dial setting and band switch settings of the radio are shown together with special instructions on the adjust-

ments to make for each signal generator setting. By following these simple instructions it is very easy to align the receiver.

The instructions in Fig. 4 are about the same as those which should be followed on most sets. The only time you might have trouble is in locating various adjustments, if a pictorial as shown in Fig. 3 is not available.

You can however readily identify the various trimmers on the schematic of a receiver, and by following the usual procedures for locating parts you can identify the trimmers on the chassis. In the schematic of the receiver shown in Fig. 1 you will note the arrows between the symbols of the i-f transformer windings. This means that adjustable cores are provided rather than trimmer condensers so you would look for slug adjustments on the i-f transformer cans. In general you will find one adjustment at the top of the transformer and one at the bottom, reached through the chassis base.

The schematic shows that the antenna and oscillator trimmers are connected in parallel with their tuning condenser sections and you would expect to find them either on the gang or mounted quite close to it. The top view of the receiver shows that the trimmers, C1A and C1B, are mounted on the gang, as you would normally expect to find them. Trimmer C21 is right in parallel with coil L-1, as shown on the schematic, and appears on the top view of the receiver.

By taking your time and by making full use of the schematic you will find it a simple matter to locate the trimmer adjustment for any receiver and by following the usual alignment procedures described here and elsewhere in your course little trouble should be encountered.

In examining the chassis layout in Fig. 2 you will see that most of the parts are connected directly to tube socket terminals. This is not always the case and parts may be widely separated from their tube sockets, although connected to them with wires. The wires may be traced visually or you can use a low range ohmmeter, placing one probe on the tube socket terminal to which the part connects and touching the other to the exposed leads of various parts until you get a zero resistance reading. The schematic will show if any other part connects to that point which should also give a zero resistance reading. If the schematic does not show connections to other components you have found the part in question when you get the zero resistance reading. If there are a number of parts connected to this point, it will then be necessary to make use of the color code, the physical appearance of the part, or its other connection points, to decide when you have the right one.

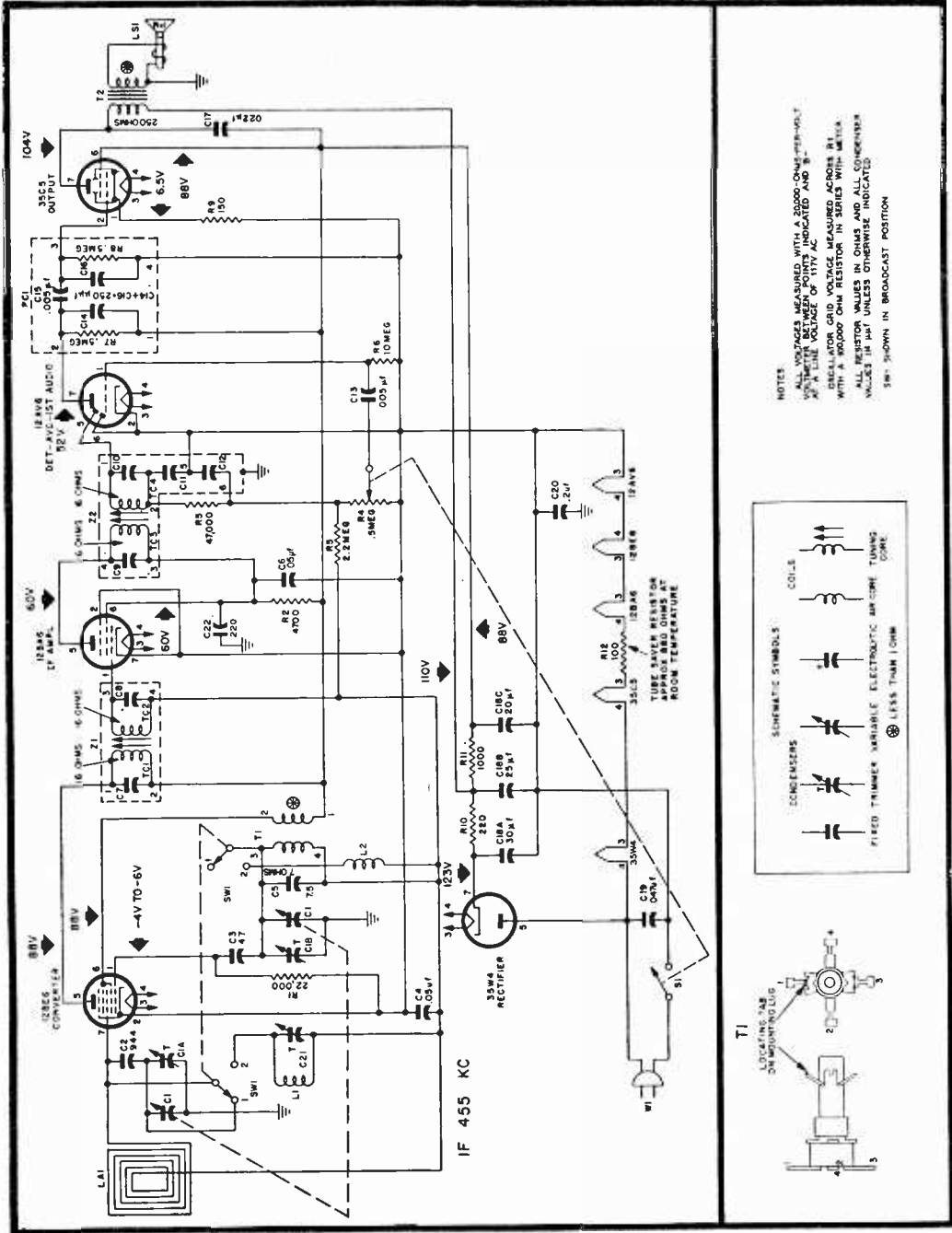

Fig. 1. Philco Radio Model 53-559, Schematic Diagram.

Courtesy Philco

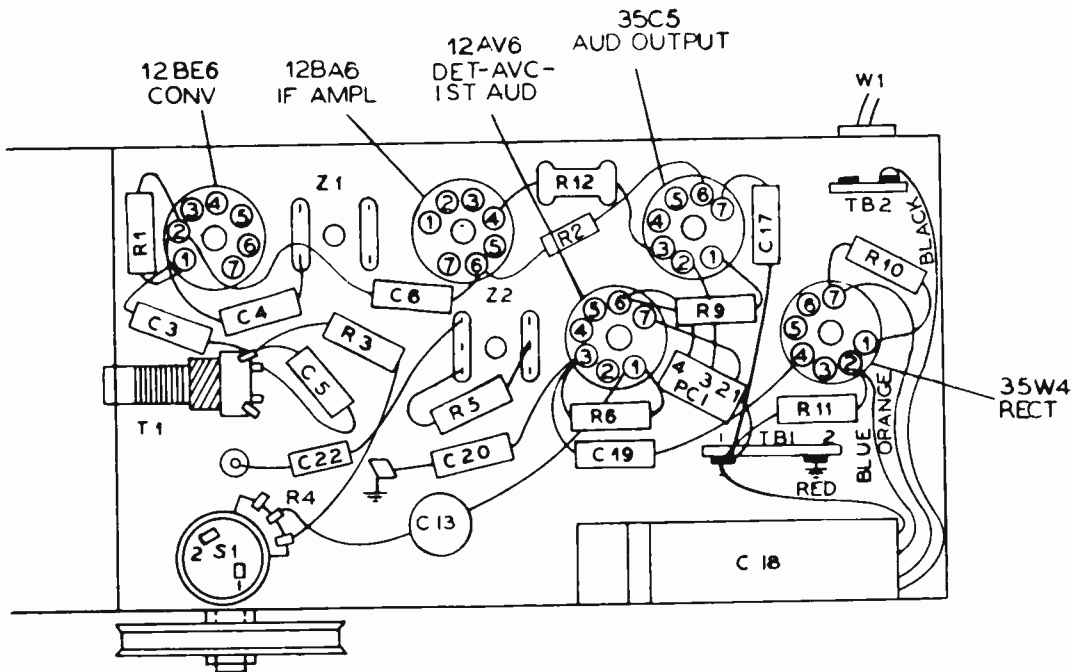

Fig. 2. Base View, Showing Parts Placement.

*Courtesy Philco*

### How Schematics Are Used in Practical Servicing

Now let us get some practical experience by going through the procedures that an expert serviceman would use in repairing the set shown in Fig. 1.

There are three situations which may arise, and we will explore each. In servicing a defective receiver the expert will, after confirming the complaint by trying the set out, make an **INSPECTION FOR SURFACE DEFECTS** and if nothing wrong is located he will use **EFFECT TO CAUSE REASONING**, or a **STAGE LOCALIZATION PROCEDURE**.

One of the above procedures will determine the course of action to follow in servicing the set. In each case the schematic will play an important part, as you will see.

Let's take the example where an inspection for surface defects shows a resistor burned out which is obviously defective because of its charred appearance.

The serviceman immediately knows that he must, in addition to determining the value of the resistor and replacing it, decide if any other part could cause the resistor to fail. If the resistor could have failed due to a defect in some other part he must decide the type of defect,

must locate the suspected part on the schematic, and decide on suitable tests of this part in the chassis.

If the tests show the part to be bad it must then be located on the chassis and disconnected for a confirming test. If doubly proven defective in this manner it must then be replaced with a part of the correct value. After all defective parts have been replaced in the receiver, it is given an air and bench check to make certain it has been successfully repaired and that no faults will develop.

In each of these operations we have listed, the schematic comes into use, as you will now see.

Suppose, when you examine the bottom of the chassis shown in Fig. 2 that you find resistor R2 to be charred so badly that its color code cannot be read. You note however that resistor R2 connects from socket terminal 6 of the 35C5 tube to socket terminal 6 of the 12BA6 tube. Now locate these tubes in the schematic in Fig. 1.

You can readily find the No. 6 pin (screen grid) of both the 12BA6 and 35C5 type tubes. You will see that resistor R2 and R11 both connect to the screen of the 35C5 but only R2 also connects to the screen grid of the 12BA6, therefore

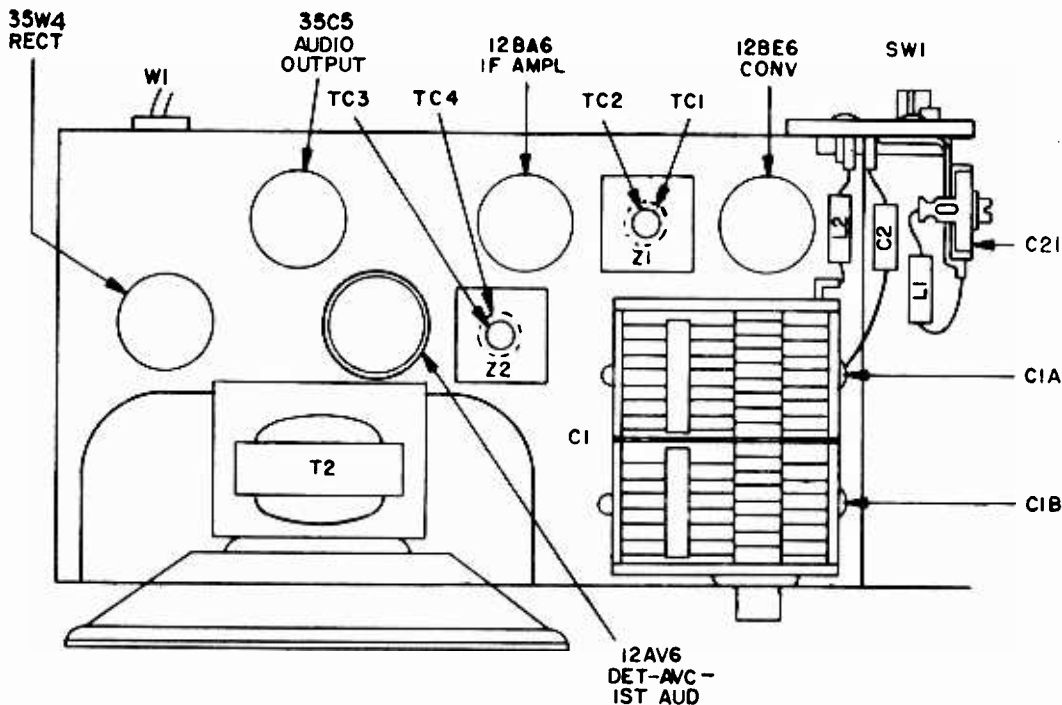

Fig. 3. Top View, Showing Tuning Adjustments.

Courtesy Philco

it must be the screen supply resistor for this tube. As you can see it has a value of 4,700 ohms. The wattage rating of the resistor is not given but a half watt resistor will do nicely and if you had the actual chassis before you, you would see that a new half watt resistor would have the same physical size as R2, thus proving their identical wattage ratings.

Is it safe to assume that resistor R2 burned out due to an internal defect? The answer is *no*, because the schematic shows that if condenser C6 were to become short circuited, resistor R2 would be connected directly across the B supply. This would cause excess current to flow through the resistor, probably burning it out. Condenser C22 is of no significance in this case since it connects to the chassis and the chassis is not an electrical part of this receiver circuit insofar as operating voltages are concerned. A complete short in C22 would not damage R2 as it would not increase the current flow through this resistor. R2, however, could burn out due to a screen grid to cathode short in the 12BA6 tube, or a short in the wiring. The first thing to do is determine if a short exists. This may be done with an ohmmeter. Place one ohmmeter test probe on B— and the other on socket terminal 6 of the 12BA6. B— is any point connecting to the ON-OFF switch. There are a number of

points which you can easily identify and to which the ohmmeter probe may be connected. For example the set side of the ON-OFF switch, the common negative lead of electrolytic condenser C18A, C18B, and C18C or socket terminal 3 of the 12AV6 tube, socket terminal 7 or socket terminal 2 of the 12BA6 tube, socket terminal 2 of the 12BE6 tube or the volume control terminal which connects to one lug of the ON-OFF switch.

With the ohmmeter probes now connected, between socket terminal 6 of the 12BA6 and a B— point, note the reading. It should be quite high, since there is normally no DC resistance path in the receiver, between these points. Actually the only normal path is through the leakage resistance of the electrolytic condensers and this should be high, on the order of 100,000 ohms or more.

Even a resistance measurement of as little as 50,000 ohms between pin 6 of the 12BA6 and the chassis would not indicate a low enough resistance path to cause R2 to burn out. Suppose however that we read a short circuit value or a resistance value of only a few hundred ohms. This certainly would cause too much current to flow through R2. It confirms the fact that there is a defect in the circuit which caused R2 to burn out. If we were to replace R2 without cor-

## ALIGNMENT PROCEDURE

**RADIO CONTROLS**—Set volume control to maximum. Set tuning control and band switch as indicated in chart.

**OUTPUT METER**—Connect across voice-coil terminals.

**SIGNAL GENERATOR**—Connect generator and set frequency as indicated in chart. Use modulated output.  
**OUTPUT LEVEL**—During alignment, adjust signal-generator output to hold output-meter reading below 1.25 volts.

### ALIGNMENT CHART

STEP	SIGNAL GENERATOR		RADIO			ADJUST
	CONNECTION TO RADIO	DIAL SETTING	DIAL SETTING	BAND-SWITCH SETTING	SPECIAL INSTRUCTIONS	
1	Ground-lead to B—; output lead through a .1-uf. condenser to grid (pin 7) of 12BE6.	455 kc.	Tuning gang fully open	Broadcast	Adjust tuning cores, in order given, for maximum output. (TC1 and TC3 are located at top of transformers.)	TC4—2nd i-f sec. TC3—2nd i-f pri. TC2—1st i-f sec. TC1—1st i-f pri.
2	Radiating loop (see note below).	1620 kc.	1620 kc.*	Broadcast	Adjust trimmer for maximum output.	C1B—osc.
3	Same as Step 2.	1500 kc.	1500 kc.†	Broadcast	Adjust trimmer for maximum output.	C1A—antenna (broadcast)
4	Same as Step 2.	3200 kc.	3200 kc.†	Special services	Adjust trimmer for maximum output.	C21—antenna (special services)

**NOTE:** Make up a 6–8 turn, 6-inch-diameter loop from insulated wire; connect to signal-generator leads, and place about 1 foot from radio loop. The position of the radio loop, with respect to the chassis, should be approximately the same as when both are mounted in the cabinet.

\*To set the tuning gang to 1620 kc., fully open the tuning gang and insert a .006-inch nonmetallic shim between the heel of the rotor and the top of the stator plates. Close the tuning gang sufficiently to hold the shim in place, and then remove the shim without disturbing the gang setting.

† To set the radio to this frequency, place chassis in cabinet, attach knob, and tune until pointer indicates the correct frequency. Then remove knob and take chassis from cabinet without disturbing the setting of the gang.

Fig. 4.

*Courtesy Philco*

recting this short the new resistor would also burn out immediately.

The tube can easily be checked by removing it from the circuit. If the screen socket terminal to B— resistance now goes up to a high value you know that there is a short in the tube. The chances are however that the reading will still be present. Then it is necessary to locate C6, which we suspect of leakage, disconnect it and check it. We do this because the trouble could be due to a short in the wiring and the actual short itself *must be found and eliminated.*

From the diagram we see that C6 connects to the screen of the 12BA6 type tube. It is also shown as being connected to B— which we previously indicated could be any of a number of points in the receiver. Instead of looking for a connection to pin 7 of the 12BA6, to the set side of the ON-OFF switch, or to some other B— point we look for a condenser connected to the screen of the 12BA6. Turning to Fig. 2 and locating the 12BA6 type socket we see that C6 connects directly to this tube socket terminal (#6), and to socket terminal 2 on the 12BE6 type tube. Either lead of C6 is then unsoldered, and the ohmmeter connected directly across both condenser leads. If a low resistance reading is obtained the condenser is defective. Suppose however that you get a high resistance reading.

This shows that the condenser is not at fault. In this case we go back to our original test point and again measure the resistance between socket terminal 6 of the 12BA6 and B—. The reading in this case would still be present and it would then be necessary to trace out the wiring until the short was found.

In practically any breakdown of this sort however you will find that the bypass condenser has failed and replacement of condenser C6 and resistor R2 will solve the problem. From the diagram we see that the condenser has a capacity of .05 mfd. The working voltage is not too important and anything from a 400 volt condenser on up will do. Since one lead of the condenser goes to B— this would be the lead marked "Outside Foil" on the replacement. When the two parts are replaced the receiver is plugged into the power line, the set turned on and an air test made. If no other trouble is encountered the job is marked "done."

Now let us consider the case where an inspection for surface defects does not indicate the cause of the trouble. Suppose that the receiver plays on only one station and that it comes in all over the dial, regardless of where the receiver is tuned. Further, suppose that this is a station operating near the low frequency end of the broadcast band.

To an experienced serviceman this immediately points to trouble in the oscillator circuit. Why? Because, when the oscillator is not working the receiver is not operating as a superheterodyne. Then a signal from a station near the low frequency end of the broadcast band, being fairly close in frequency to the i-f amplifier, goes through the converter and i-f stages, reaches the second detector where it is demodulated and is passed through the audio amplifier to the speaker. The fact that you can tune the receiver anywhere on the dial and still pick up the same station is a sure sign that the oscillator is not working and is not beating with the incoming signal to produce an i-f signal. The selectivity afforded by the loop and its tuning condenser is not great enough to exclude the station completely.

The first thing to do when confronted with such a symptom is to confirm your suspicion of oscillator failure, by checking to see if the oscillator is working. This may easily be done by measuring the DC voltage across oscillator grid resistor R1, shown in Fig. 1. You will note on the schematic that you should measure between -4 and -6 volts. The diagram shows that your voltmeter test probes should be connected between socket terminals 1 and 2 of the 12BE6, making it unnecessary to look for R1. If you measure a very low voltage, one volt or less, or no voltage, it shows that the oscillator is at fault. The first thing to do is try a new 12BE6 tube regardless of the manner in which the present one tests.

If this does not prove to be the cause of the trouble you should then check the oscillator coil windings for continuity with your ohmmeter and make certain that the tuning condenser (or its trimmer) is not shorted. The schematic enables you to decide where to place your test probes. You can easily check the tuning condenser with an ohmmeter by placing one ohmmeter probe on the chassis and the other on the stator lead of the oscillator section of the tuning condenser gang. Normally a reading should not be obtained across this condenser at any dial setting. If a reading is obtained the condenser plates may be bent and shorting to each other. You can check on this quickly, by unsoldering the lead on the stator plates. If this eliminates the short across the condenser the condenser itself is not defective. If, however, the short is still present then the condenser is at fault and the plates must be carefully examined and straightened so they no longer touch each other.

The feed-back winding with terminals marked 1 and 2 on the oscillator coil may readily be checked with your ohmmeter. It is not necessary to find the coil at all. The schematic shows that the continuity of this winding may be tested by placing one ohmmeter test probe on socket 6

of the 12BE6 and the other on socket terminal 5. If a reading of a fairly low resistance is obtained this proves that the oscillator coil between terminals 1 and 2 is not open. The reading is obtained through this winding and through the primary of the i-f transformer. It would, of course, also be possible to check this winding by measuring the screen to the cathode voltage of the 12BE6 with a DC voltmeter. You should obtain a positive voltage of about 88 volts on the screen of the tube and if you do, this shows that the coil which is in the screen supply circuit cannot be open.

The tank section of the coil may also be checked with your ohmmeter. With the set turned off you should connect one ohmmeter test probe to the stator of the oscillator section of the tuning condenser and the other to some point in the receiver in contact either directly or through a fairly low resistance with terminal 4 of the oscillator coil. For this purpose we could use terminal 1 of the 12BA6 or terminal 7 of the 12BE6, whichever is most convenient. When using either test position a reading shows that the tank winding of the oscillator coil is not open.

Should you find that the oscillator coil does not have open windings there is a possibility that the value of resistor R1 has changed. This may be determined without finding R1 on the chassis by measuring the DC resistance between socket terminals 1 and 2 of the 12BE6 tube. A reading of about 22,000 ohms should be obtained. The only other part in the oscillator circuit which might cause trouble is condenser C3. This condenser is so small that it can best be checked by substitution. A 50 mmfd condenser which is readily available could be substituted in place of C3.

You will note, from the schematic, that the rotor of the oscillator section of the tuning condenser connects to the chassis while terminal 4 of the oscillator coil does not connect to the chassis. However, the electrical connection between oscillator coil terminal 4 and the chassis is through condensers C4 and C20. An open in either of these condensers could stop the oscillator. They may be checked by shutting other condensers of about the same size across points in the chassis to which they connect, noting the effect on the DC voltage between socket terminals 1 and 2 of the 12BE6 type tube.

You have seen that without locating any parts in the oscillator circuit with the exception of C3, we have determined which part is at fault. The defective part is then located on the chassis by tracing to it from a known point. It may then be replaced.

In many instances you may find that everything tests O.K. according to the checks given above but that the oscillator still does not work. This points definitely to a defective oscillator coil.

Frequently these coils will absorb moisture or a short may occur between one or two turns on the coil. This will not materially change its resistance or affect its continuity and yet the oscillator coil is defective. The only way to check, in such a case, is to install a new replacement coil, which may be obtained through your local distributor.

In making the above diagnosis, which would be followed by an expert serviceman, you have seen for yourself the value of the schematic diagram. It not only shows you what parts to check but makes it possible to test them, without going to the trouble of actually locating the part in the chassis. When you have decided which part is defective, the schematic makes it possible to locate it in the chassis even if a parts layout is not available. This makes part replacement easy.

You have seen how an inspection for surface defects and effect-to-cause reasoning have solved trouble in two cases. Now, however, suppose the receiver is dead, and that no sound is coming from the loudspeaker. Obviously, you cannot decide from such a symptom that the trouble is due to some specific part or is even in some specific section of the receiver. Also an inspection does not indicate any burned out parts so in this case we cannot use Effect-To-Cause-Reasoning, or an Inspection-For-Surface-Defects to point the way to the solution of the problem. Here, the thing to do, is to localize the trouble to one stage. The localization procedure is extremely simple.

Turn the set on and allow it to warm up a normal length of time. Then, touch the center terminal of the volume control, to which C13, connects with your finger. This should result in a loud buzz from the speaker, if everything is all right between this point and the speaker. If the buzz is heard, the trouble is between this point and the antenna. Let's assume that no buzz is heard. You should next touch the socket terminal 1 of the 12AV6 tube with your finger. If you got a buzz this time it would show that C13 was open. If no buzz obtained you could try touching socket terminal 2 of the 35C5 tube with your finger or with a screwdriver, your hand touching the metal blade of the screwdriver being careful not to touch the chassis with any part of your body. Again some sound, even though quite weak, should be heard in the speaker. If no sound is heard you can assume that the trouble is between the 35C5 and the loudspeaker. Now you would resort to voltage measurements.

With the set turned on place your negative voltmeter probe on B—, which may be any of the points previously described, and touch your positive voltmeter probe to socket terminal 6 of the 35C5 tube. A reading of about 88 volts should

be obtained. If you get such a reading it shows that there is nothing wrong with the power supply. Next move your positive voltmeter probe to socket terminal 7 of the 35C5 tube. In this instance you should measure a higher voltage than on the screen—about 104 volts, as shown on the schematic. If you do, it shows that there is nothing wrong with the primary of the output transformer. As your meter connects to socket terminal 7, there will be a slight change in current flowing through the primary of T2. This should produce a click in the loudspeaker. If it does it shows that the secondary of the transformer is all right and that the speaker voice coil is not open. If none of the tests point to the cause of the trouble it begins to look as though the 35C5 tube may be defective as it is apparently not drawing plate current.

Before deciding on a bad tube however, measure the plate to cathode voltage. You may be amazed to find that although you had plate voltage when measuring between the plate and B— there is no plate to cathode voltage. This shows that resistor R9 must be open. A check between socket terminal 1 of the 35C5 tube and B— will confirm that R9 is open since you would measure a very high voltage. This is due to the fact that resistor R9 is effectively not in the circuit and that the high resistance of your voltmeter takes its place. The cathode current of the tube, flowing through the resistance path offered by your voltmeter, produces the high voltage drop which you read on the meter.

You would make a further confirmation however, by turning the set off, and by checking from socket terminal 1 of the 35C5 to B— with your ohmmeter. You would probably read an extremely high resistance or the meter would indicate a complete open in the circuit. Resistor R9 should then be located and although it may appear to be intact you can be certain it is open, and can recheck by disconnecting one of its leads and measuring directly across both leads with your ohmmeter.

Before installing a new resistor at this point and considering the job done look at the diagram and see if you can determine any reason why R9 burned out. There are no condensers connected in such a way to cause excess B supply current to flow through R9 so you can assume that the tube was simply drawing too much current. Of course you don't want to replace R9 and have it burn out again so the thing to do is to decide why the tube might draw excess current.

An experienced man would know that a tube would draw excess current if it were gassy, or if the coupling condenser, in this case C15, were so leaky as to place a positive bias on the tube. There is one way to check on this quickly. Connect a DC voltmeter from socket terminal 2

*(Page 24, please)*

# PLACE CHRISTMAS ORDERS NOW

EACH year at this time we receive many letters from students and graduates, members of their families and even friends inquiring about the NRI Professional Test Instruments, and other NRI services, with a view of purchasing them for Christmas presents. For your convenience we give, in the following several pages, condensed information about these items.

We urge our readers, who are prepared to send orders to do so very promptly. For those who must wait until nearer Christmas, we promise to try to make shipments within one day of receiving order. That means Monday's orders, for example, are shipped Tuesday. Tuesday's orders are shipped Wednesday, etc., but Friday's orders are shipped Monday. The Institute is closed on Saturdays.

Mail moves slower at this season. A letter may take a day or two longer to reach us. Likewise, shipments move slower, too. We will do everything we can to rush shipments but please help us avoid impossible situations. Every year we receive orders within a few days of Christmas marked "Christmas present, please rush" or "Must get here before Christmas," with not enough time for the shipment to get there. That leads to disappointments.

One more important point. A father, mother, wife, sweetheart or friend may purchase these items for a student or graduate, but we should have the student's name and student number as part of our record. To keep the present secret from the student, the shipment may be sent to any address designated.

So, mail your orders early. We'll extend every possible cooperation to help make the lucky recipient of the shipment have a Merry Christmas.



## WELLER SOLDERING GUNS "Dual-Heat"

110-120 volts, 60 cycle A.C.

- Heats in an instant
- Cools quickly too
- Reaches "inaccessible" spots
- Built-in dual spotlights

Here is the ideal soldering tool for the Radio and Television serviceman. A perfect X-mas gift. It eliminates those tedious minutes of waiting for your soldering iron to heat. Just plug in your WELLER Soldering Gun, pull the trigger, and in seconds you are ready to solder—a real time saver! Trigger controlled dual heat gives you low heat for circuit connections and high heat for chassis soldering.

You'll save in operating costs. Many servicemen leave their regular soldering irons connected continuously, hour after hour, while actually soldering only a few joints. The WELLER operates only while actually in use. This eliminates frequent replacing of oxidized and pitted soldering tips. Saves on electricity bills, too.

Plenty of heat—concentrated right where you want it—in a small tip. Getting into tight inaccessible places is easy with a WELLER. In fact, you will solder in tight spots where an ordinary iron simply cannot reach. After trying your new WELLER, you'll agree that a soldering gun is "the" solution to your soldering problem.

Each WELLER gun is fully guaranteed against defects in material and workmanship. Tips are easily and economically replaced.

### Choice of two Models:

100-150 watt (D-440) List price \$14.90. NRI's Price **\$10.73** (For ordinary Radio-TV work.)

200-275 watt (D-550) List price \$16.25. NRI's Price **\$11.71** (For heavy duty as well as Radio-TV.)

Shipped by parcel post, prepaid. Order blank is found on page 23.





## NRI Professional Tool Kit

INCLUDES ROLL-UP CARRYING CASE

A kit of fourteen carefully selected, good quality tools, complete with roll-up carrying case. You will be proud to own this fine kit of tools. They are just what NRI recommends for doing your experiments. Will last well into your professional Radio and Television Servicing career.

This is a real money-saving value. If bought at dealer's net prices, it would cost you about \$10.50. Yet NRI's price is only \$8.95, including the strong canvas carrying case. The items included in the kit are as follows:

1. Long nose pliers. Professional grade, precision made, of tool steel. Polished head. Smooth handles.
2. Diagonal cutters. Precision made from tool steel. Professional quality.
3. Metal cutting saw. Removable, four position blade. Light, but very sturdy.
4. Eight inch file. An indispensable item.
5. Slip joint pliers. For general utility.
6. Double blade neutralizing tool. Designed for new miniature i.f. transformers.
7. Four-in-one bone fibre neutralizing tool. Necessary for aligning receivers.
8. Small screwdriver. Slender four-inch blade.
9. Nut driver. For five-sixteenths inch hex nuts. Good quality, plastic handle.
10. Nut driver. Same as above, for one-fourth inch hex nuts.
11. Phillips screwdriver. For Phillips screws widely used in Radio and TV. Plastic handle.
12. General utility screw driver. Good quality.
13. Plastic long nose pliers. Shock proof. Used to move "hot" wires in Radio and Television sets.
14. Volume control wrench. Correct size for tightening volume controls and toggle switches.

**Only \$8.95**

Tool kit shipped, complete with carrying case, by parcel post, prepaid. Individual tools or carrying case not sold separately. Order blank page 23.



## A Professional-Appearing Metal Cabinet for the 2-E and 2-CK NRI Electronic Multitester

NRI students and graduates are justly proud of the performance and appearance of the NRI Electronic Multitesters which they build. Now you can give your NRI Electronic Multitester a professional look by installing it in this beautiful cabinet. This cabinet has a Marine gray ripple finish. The color harmonizes perfectly with the front panel included with your Electronic Multitester kit. It is made of high-grade cabinet steel sturdy enough to take rough handling. A swell job! Something which every NRI student and grad would be proud to have for his Electronic Multitester.

**Cabinet Protects Your Tester  
Makes It Easy To Carry**

An attractive black and red moulded bakelite handle makes carrying your tester easy. You will be pleased and your service customers surprised, because of its professional appearance. This cabinet is made to fit your tester exactly. In addition to improving the tester's appearance, it protects the tester from dust and damage. The installation requires but a few minutes. All necessary screws and hardware are included.

It is important to note that this cabinet cannot be used with the old 2RK NRI Tester. It is available only for the newer 2-E and 2-CK NRI Electronic Multitesters, which have a slanting front panel.

**Only \$3.75**

Shipped by parcel post, prepaid. Order blank on page 23.



MODEL 11

## NRI Professional Vacuum Tube Voltmeter

IDEAL FOR RADIO OR TELEVISION WORK

This VTVM is a top performer among moderate priced instruments. It's accurate, good looking, and easy to operate. Especially good for beginners, since meter movement is electronically protected against reasonable overloads. Five basic types of measurements are provided.

1. **D.C. volts**—six ranges, maximum 1200 volts.
2. **A.C. volts**—six ranges, maximum 1200 volts.
3. **Ohms**—six ranges, maximum 2,000 megs.
4. **D.C. Zero Center Scale**—for FM alignment.
5. **Output Measurements**—includes d.c. blocking condenser.

### Specifications

**Panel:** Black enamelled etched characters.  
**Case:** Black molded bakelite; 7½" x 5½" x 3".  
**Meter:** 200 micro-ampere, double-jewelled, large 4½" x 4¼" meter scale—easy to read.  
**Input Resistance:** 11 megohms.  
**Tubes:** One 12AU7; one 6x4; and selenium rectifier.  
**Includes:** Operating instructions; AC-DC-ohms cable with d.c. isolating probe and detachable alligator clip.  
**Power Required:** 50-60 cycle, 110-120 volts a.c.  
**Actual Weight:** 4 lbs. **Shipping Weight:** 6 lbs.  
**Warranty:** Standard 90 day RTMA warranty. Shipped express charges collect. Use order blank on page 23.

Only \$38.50

Optional Accessories for Model 11

**High Voltage TV Probe.** Extends d.c. volts range to 30,000 volts. \$8.00, postpaid.  
**Crystal Detector HF Probe.** Reads positive peak sine-wave voltages up to 250 mcs., \$.65, postpaid.  
**Custom Leather Case.** Top grain cowhide. Has tool compartment. Water-proof, lined suede interior, \$9.50, postpaid. (Also for Mod. 46, right.)

Page Eighteen



MODEL 46

## NRI Professional Volt-Ohm Milliammeter

20,000 OHMS PER VOLT SENSITIVITY  
 COMPLETELY PORTABLE  
 NO EXTERNAL POWER NECESSARY

The Model 46 NRI Professional Volt-Ohm-Milliammeter has been designed to fill the need for an inexpensive, fully portable radio and television servicing instrument. A wide range of measurements is provided.

1. **DC volts**—five ranges, maximum 1200 volts.
2. **AC volts**—five ranges, maximum 1200 volts.
3. **Ohms**—three ranges, maximum 60 megohms.
4. **Microamperes**—0-120.
5. **Milliamperes**—four ranges, maximum 1200 milliamperes.
6. **Output measurements**—dc blocking condenser and special output jack. Also, dc voltmeter has plenty of sensitivity for avc or agc measurements.
7. **Decibels**—five ranges.

### Specifications

**Panel:** Black enamelled; etched characters.  
**Case:** Black bakelite; 7½" x 5½" x 3".  
**Meter:** 50 microampere, double-jeweled, large 4½" x 4¼" meter scale.  
**High quality components:** ±1% resistors used throughout.  
**Actual weight:** 3½ lbs. **Shipping weight:** 5 lbs.  
**Includes:** Complete operating instructions, test leads, clips and ohmmeter batteries.  
**Warranty:** Standard 90 day RTMA warranty.

Only \$33.50

Optional Accessories for Model 46: **High Voltage TV Probe.** Extends dc volts range to 30,000 volts. \$8, postpaid. Order Blank page 23.  
**Custom Leather Case.** \$9.50, postpaid. Same as for Model 11 VTVM described at left.

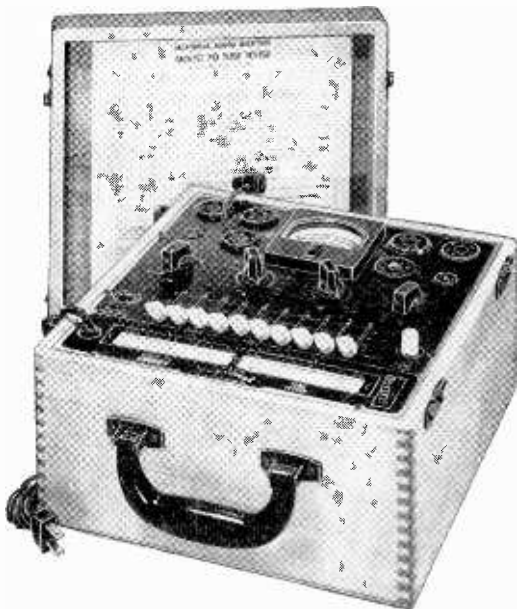

MODEL 70

## NRI Professional Tube Tester

WITH BUILT-IN ROLL CHART

Designed to test the latest Radio and Television tubes. Convenient, built-in roll chart. Comes complete with detailed instruction manual. Approved RTMA emission circuit keeps the possibility of obsolescence at the very minimum. Specifications:

1. **Employs Standardized RTMA Emission Test Circuit**—Ten separate four-position tube element switches make tube prong connections flexible—take care of future electrode connections.
2. **Eight Tube Test Sockets**—Tests 4, 5, 6, 7, and 7L prong tubes; plus octal, loctal, 7-prong miniature; and 9-prong miniature tubes.
3. **Fifteen filament Voltage Taps**—0.75, 1.5, 2, 2.5, 3.3, 5, 6.3, 7.5, 12.6, 18.9, 25, 35, 50, 70, and 110 volts; filament voltages for all receiving tubes.
4. **Filament Continuity Test and Open Element Test.**
5. **Handsome Professional Looking Hardwood Case**—Beautiful natural grain, clear lacquer finish. Size: 10 $\frac{3}{4}$ " x 10 $\frac{3}{4}$ " x 6 $\frac{1}{4}$ ".
6. **Actual Weight**—11 pounds. **Shipping Weight**, 13 pounds. Shipped express charges collect.
7. **Power Requirements**—50-60 cycle, 110-120 volts A.C. required.
8. **High Speed, Double Window Roll Chart.**
9. **Standard 90 day RTMA Warranty.**

Price \$49.75

Our newest model tube tester has been engineered and priced exclusively for NRI men. It is a truly professional test instrument—one which will give your customers confidence in your work. Ideal for beginners or "old hands."

## TV Picture Tube Adapter



May be used with all NRI Professional Tube Testers, Models 66 through 70. (Not usable with NRI Model 1185.) This Adapter enables you to test a Television picture tube in a receiver, or in the original factory carton. The test includes a cathode emission check and a check for shorts between the various elements in the tube. Manufacturers do not claim that a Television Picture Tube Adapter is a fool-proof means of testing Television picture tubes. There are certain comparatively infrequent troubles in picture tubes which an Adapter will not detect. It is, nevertheless, a popular and useful accessory.

Only \$4.98

Complete with instructions. Shipped parcel post, prepaid. Order blank on page 23.



# Speedex

FULLY AUTOMATIC

## WIRE STRIPPER

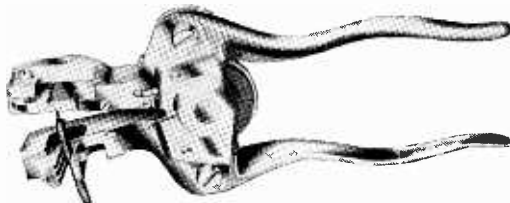

WILL NOT CRUSH  
STRANDED WIRES

Here's the completely new "766" series Speedex "Speed-O-Matic" wire stripper. Fully automatic with "delayed return action" to prevent crushing of fine stranded wires. Sturdy, easy to use with narrow easy grip handles for easy handling. Interchangeable hardened steel blades that can be purchased separately to meet all wire stripping requirements. For #10, 12, 14, 16, 18, 20, 22 wire. List price \$8.25. **NRI price \$4.95.** Shipped post-paid. Order blank page 23.

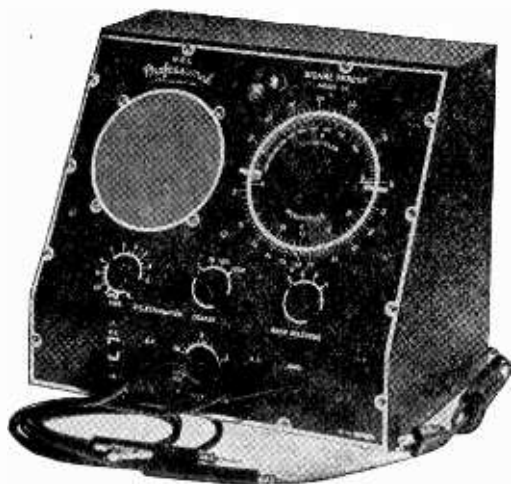

MODEL 34

## NRI Professional Signal Tracer

### TUNED CIRCUITS—GIVE HIGH PERFORMANCE

Signals can be traced from antenna to loud-speaker. Trouble is quickly localized in dead receivers. Greatly assists beginners or experienced serviceman in finding stubborn cases of hum, noise, or distortion. Sources of oscillation in r.f. or i.f. stages can be quickly isolated. Two separate inputs make the instrument ideal for tracing down intermittent trouble.

One special use for this instrument is in measuring the "gain-per-stage." Also, because this instrument uses two stages of tuned radio frequency amplification, it can readily be used for alignment purposes. A Signal Generator is not essential. The actual broadcast station signal is used instead. The instrument is practically fool proof—anyone can safely use it. Detailed instruction manual is included. Specifications:

1. Power requirements—50 to 60 cycle, 110-120 volts a.c., only.
2. Sturdy maroon crackle finish case—12" x 8¼" x 10¼". Handsomely etched aluminum panel.
3. Tubes included: 2—6BA6; 1—6SQ7; 1—6K6-G; 1—6E5; and 1—5Y3-G.
4. Frequency coverage is 170 kc. to 11.3 mc. in four bands.
5. Five inch dynamic loudspeaker provides audio output. Also has visual output indicator.

**Price \$57.50**

Actual weight—15 lbs. Shipping weight—18 lbs. Shipped by express, collect. Please use order blank on page 23.

Page Twenty



MODEL 112

## NRI Professional R-C Tester

No Radio and Television service shop is complete without a reliable resistor-condenser tester. Such an instrument speeds up your service work, enabling you to increase your profits and your customer goodwill.

Here's what you can do with this instrument: (1) Measure power factor of electrolytic condensers. (2) Measure capacity of all types of condensers. (3) Check all types of condensers for leakage or break-down by applying actual d.c. working voltage. (4) Accurately measure resistor values in ohms and megohms. Specifications:

1. Capacity Ranges: Directly calibrated from .0001 microfarad to 200 microfarad, in six ranges. Will measure down to 10 mmfd.
2. Resistance Ranges: 10 ohms to 20 megohms, in six ranges.
3. Bridge Type Circuit, linear calibrated main scale.
4. D.C. voltage up to 600 volts for leakage test.
5. Complete with four tubes: 1-V, 6Y6G, 6SL7, and 6E5.
6. Power requirements: 110 to 120 volts, 50-60 cycle a.c. only.
7. Maroon colored, crackle finish cabinet. Measures 10 inches by 8 inches by 7½ inches.
8. Actual weight 9 pounds. Shipping weight, 11 pounds.
9. Complete with instruction manual, rubber covered test leads, and special test plugs.

**Only \$36.50**

Shipped by express, collect.



MODEL 88

## NRI Professional Signal Generator

FUNDAMENTALS: 170 KCS. TO 60 MCS.

Designed specifically for rapid, easy alignment of radio receivers. Extremely accurate and easy to operate. Frequency coverage ideal for all AM servicing, as well as i.f. used in FM and Television. Strong harmonics and accurate calibration make the instrument useful up to 120 mc.

Invaluable in isolating the defective stage in a "dead" receiver, or in checking an audio amplifier. A stable Hartley electron-coupled oscillator circuit is used, with a cathode follower output stage. Single output jack with detachable coaxial lead. Coarse and fine r.f. attenuators. R.F. modulated, R.F. unmodulated, and 400 cycle audio output. Specifications:

1. Frequency coverage: 170 kc. to 60 mc. In six carefully selected bands.
2. Guaranteed accuracy:  $\pm 1\%$  on the first 3 bands and  $\pm 1\frac{1}{2}\%$  on the 3 highest bands. (Average accuracy is better.)
3. Tubes included: 1—6BE6; 1—6SN7; 1—5Y3.
4. Sturdy maroon crackle finish case with handsomely etched aluminum panel. Size 12 inches by 8 $\frac{1}{4}$  inches by 10 $\frac{1}{4}$  inches.
5. Actual weight 12 pounds. Shipping weight 15 pounds. Shipped complete with detailed instruction manual.

Price \$42.50

Shipped by railway express, collect. Please use order form on page 23.



## "A" Battery Eliminator For Testing Auto Radios

This rugged, heavy-duty "A" Battery Eliminator is manufactured by ATR, a recognized leader in its field. NRI men can purchase this fine piece of equipment through NRI at the Dealer's net price of only \$33.50. This is the finest and most complete instrument of its type which we know of in this price range.

### Specifications

TYPE 610C-ELIC—Rated output 6 volts at 10 amperes continuous or 12 volts at 6 amperes continuous. Either output obtainable by means of simple output terminal switching arrangement.

Equipped with Full-Wave Dry Disc Selenium Rectifier, Assuring Noiseless, Interference-Free Operation and Extreme Long Life and Reliability. Can also be used as a battery charger.

On-Off Switch, 8-Position Voltage Control, Meters, Fuse Protection, Rubber Mounting Feet, 6-ft. All-Rubber Cord Set, and Cabinet of heavy gauge metal having attractive grey-hammerloid finish. Size 6 $\frac{1}{2}$ " x 9 $\frac{1}{8}$ " x 8 $\frac{1}{2}$ ".

Only \$33.50

Shipping weight, 22 lbs. By Express, collect. Instructions and warranty included.



## Radio Replacement Parts Kit

INCLUDES STURDY STEEL TOOL BOX

Commonly needed Radio replacement parts. Ideal for the man who wants to get an inexpensive start. Also just the thing for a man already doing Radio and TV service work. If this kit were bought from a Radio parts distributor, it would cost approximately \$40. We offer it for only \$21.75. The parts are standard, fresh, first-quality—they are not surplus. Made by well-known manufacturers. Many parts packed in manufacturer's cartons. Here is what the kit includes:

1. Sturdy steel tool box, 16 inches by 7 inches by 7 inches, with pop-up tray.
2. Two 456 kc. i.f. transformers, one standard size, and one miniature size.
3. A matched set of 2 r.f. replacement coils for t.r.f. receivers.
4. Two 25 ft. rolls of flexible indoor antenna wire, wound on antenna hanks.
5. One antenna coil and one oscillator coil (matched) for either a.c.-d.c. or a.c. sets.
6. Box containing 10 assorted pilot lamps.
7. Dial cord and belt replacement kit, including springs, fasteners, and other hardware.
8. Paper tubular condensers—twenty-five most popular sizes, rated at 600 volts.
9. Fixed resistors—one hundred popular sizes and wattage ratings.
10. Electrolytic condensers—eight widely used types for a.c. and a.c.-d.c. receivers.
11. Two high-grade plastic line cords.
12. One universal output transformer for either single-ended or push-pull output.
13. One A.C.-D.C. output transformer.
14. Scratch filler, for hiding cabinet scratches.
15. One tube of speaker cement and one bottle of solvent.
16. Volume control kit—six popular volume controls, four switches, eight assorted shafts.
17. Two popular types of selenium rectifiers.
18. Two jars full of standard radio hardware.

**Only \$21.75**

Shipping weight is 15 pounds. All Replacement Parts Kits are shipped express, collect. Please use order form on next page.

Page Twenty-two

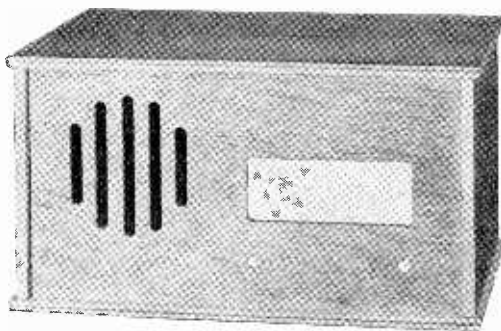

## A Beautiful Cabinet For Your NRI Radio

The cabinet is well seasoned natural wood, unpainted. You can, if you wish, give it two or three coats of clear lacquer, or paint it your favorite color to match the room. Four neat rubber bumpers prevent scratching or marring furniture on which you may set your Radio.

The sides, top, and bottom are made of  $\frac{3}{8}$  inch 5 ply White Gum sanded to a smooth finish. The front panel is attractive Philippine Mahogany. The grille cloth is rich green, harmonizes with the color of the dial scale. The back is open.

**Mailed knocked down. Easy to assemble.**

Notice the cabinet will come to you knocked down. That is to avoid possible damage in shipment. The sides, top and bottom are rabbeted. Everything slips perfectly and securely into place. It's fun to assemble—a very easy job. No dirt, no fuss. No nails or screws. You simply apply a bit of glue into the grooves, use a little hand pressure and your cabinet is complete.

Slipping your Radio into the cabinet is a two minute job. You'll notice a big improvement in the tone immediately. You'll have an attractive Radio for your den, living room or bedroom.

Sent parcel post, prepaid. Read important note below. Please use Order Blank at right.

**Only \$4.95**

Be sure to check whether you have the NRI Radio built from parts supplied with Kit 7RK or from Kit 7E. This is important because there is a slight difference in size in the two cabinets.



## NRI Service Manuals Save You Time and Money

### NOW—TWO BIG NRI SERVICE MANUALS

NRI service manuals contain radio circuit diagrams and information which is most frequently requested from NRI. This is our answer to your radio diagram problem. More than 10,000 NRI students and graduates have already purchased one or both of these manuals. Volume II follows Volume I to bring this diagram service up to 1949. They are companion books you will be proud to own.

**Volume I contains most frequently needed diagrams of receivers built before 1946.**

**Volume II contains most frequently needed diagrams of receivers built during 1946-1949.**

These are big, sturdy manuals. Circuit diagrams are in detail, with parts values, and many illustrations. I.F. values and alignment data are included. A complete, cumulative index is also included with each manual. (Do not include Canadian receiver diagrams.)

**\$15.95 Each**

Sent parcel post, prepaid. Please use Order Blank at right.

## Use Order Blank Below

All test instruments and the NRI Parts Kit are shipped by Railway Express, charges collect. Tool Kits, Soldering Guns, Diagram Manuals, Radio Cabinets and VTVM Accessories are shipped by parcel post, prepaid.

### ORDER BLANK

National Radio Institute, Supply Division,  
16th and U Streets, N.W.,  
Washington 9, D. C.

I enclose \$\_\_\_\_\_ (money-order, check or bank draft). Send me the following material:

- 100-150 Watt Weller Soldering Gun, parcel post prepaid. Price \$10.73.
- 200-275 watt Weller Soldering Gun, parcel post, prepaid. Price \$11.71.
- NRI Professional Tool Kit, parcel post, prepaid. Price \$8.95.
- 2-E and 2-CK Steel Cabinet, parcel post, prepaid. Price \$3.75.
- Model 11 NRI Professional Vacuum Tube Voltmeter, express collect. Price \$38.50.
- High Voltage Television Probe for Model 11. Parcel post, prepaid. Price \$8.00.
- Crystal Detector Probe for Model 11. Parcel post, prepaid. Price \$6.65.
- Leather Case for Model 11 or Model 46. Parcel post, prepaid. Price \$9.50.
- Model 46 NRI Professional Volt-Ohm-Milliammeter, express collect. Price \$33.50.
- High Voltage Television Probe for Model 46. Parcel post, prepaid. Price \$8.00.
- Model 70 NRI Professional Tube Tester, express collect. Price \$49.75.
- TV Picture Tube Adapter, par. post. Price \$4.98.
- Automatic Wire Stripper. Par. post. Price \$4.95.
- Model 34 NRI Professional Signal Tracer, express collect. Price \$57.50.
- Model 112 NRI Professional Resistor-Condenser Tester, express collect. Price \$36.50.
- Model 88 NRI Professional Signal Generator, express collect. Price \$42.50.
- "A" Battery Eliminator, exp. col't. Price \$33.50.
- NRI Professional Replacement Parts Kit, express collect. Price \$21.75.
- 7RK Radio cabinet, shipped unassembled, parcel post, prepaid. Price \$4.95.
- 7E Radio cabinet, shipped unassembled, parcel post, prepaid. Price \$4.95.
- Volume 1 NRI Service Manual, parcel post, prepaid. Price \$15.95.
- Volume 2 NRI Service Manual, parcel post, prepaid. Price \$15.95.

Name ..... Student No.....

Address .....

City ..... Zone .... State .....

Express Office .....

If you live in Washington, D. C., add 2% for D. C. Sales Tax.

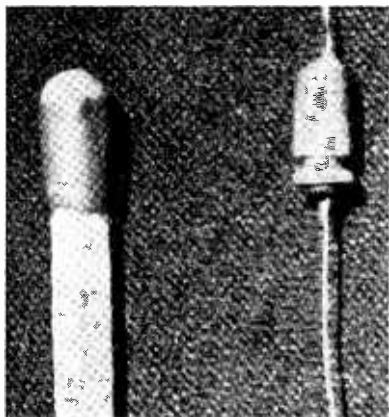

## Tiny Tantalum Capacitor, Companion for Transistor Announced by General Electric

A tiny tantalum capacitor, believed to be the smallest high capacity unit ever designed for low voltage, direct current applications, has been announced by the General Electric Company's Capacitor Department at Hudson Falls, New York. (Shown above at right; a match appears at left.)

It will make possible further size reductions in miniaturized assemblies using transistors and is intended as a companion for the transistor, G-E engineers said. The new unit is so small—5/16 inch long and 1/8 inch diameter—that it



has been termed a "micro-miniature" capacitor. The capacitor can be used in hearing aids and, in many instances, can be applied in transistorized military equipment.

G-E engineers believe it will also aid in opening the door for commercial applications of miniature electronic products.



## USING DIAGRAMS

(Continued from page 15)

of the 35C5 tube to B—, with the positive volt-meter probe on socket terminal 2. A new 150 ohm resistor should be installed in place of R9. Turn the set on, and carefully watch the meter. If it starts to read up scale turn the receiver off at once so that the increasingly positive grid voltage on the 35C5 will not raise the cathode current to the point where R9 would be damaged. Now you know that there is a positive voltage on the grid of the 35C5. This could be caused by gas in the tube, or by leakage in C15. You can check on both possibilities by unsoldering the lead from terminal 1 of printed circuit PC1. Now, even if C15 is leaky there will be no path from the positive side of the B supply through it to the grid of the 35C5.

Again, turn the set on, and read the voltage between the control grid of the 35C5 and B—. If this time the voltage does not go positive, you will see that we have leakage in C15. Due to the structure of this printed circuit there is no way to cut out C15, and it would be necessary to replace the entire printed circuit.

Suppose, however, that with the B supply disconnected from the printed circuit you still measure a positive voltage between the control grid of the 35C5 and B—. This would show definitely that the tube was gassy. The insertion of a new tube would, in turn, show that the voltage no longer existed, and replacement of the tube would solve the problem.

You could not be expected to handle all service problems if you are in the first part of your course but continued study will show you how to analyze all sorts of radio defects. Examples, such as those we have given in this article show why it is so necessary to learn how parts work individually and together in a circuit. Once you understand the action of the parts, and know the purpose they are to play in receiver circuits it's easy to determine why failure of some particular part may produce a certain symptom. Then it's easy to decide, with a schematic, how the parts should be tested and to make a replacement.



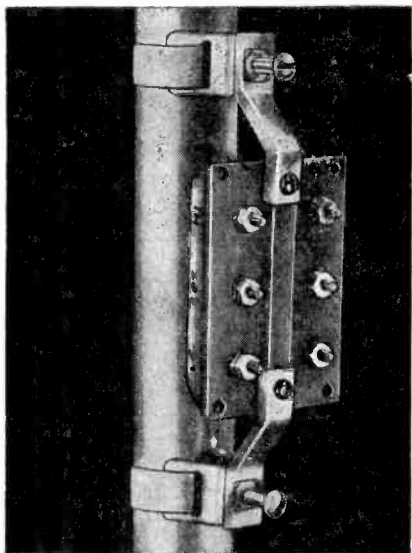

### New TACO VHF Hi/Low Magi-Mix Coupler Announcer

A new Taco VHF antenna coupling device providing best impedance matching and maximum signal transfer is announced by Technical Appliance Corporation, Sherburne, N. Y. A companion unit to the now famous UHF/VHF Magi-Mix, the new device, known as the Taco Cat. No. 1425 VHF Magi-Mix, is enclosed in a plastic housing with straps attached for positive mounting. Not adversely affected by moisture.



### New RCA Camera Tube is Smallest Ever Designed for Commercial TV

Vidicon-type for Film Pickup Weighs Two Ounces Yet Has Triple the Sensitivity of an Iconoscope

Harrison, N. J.—The smallest TV camera tube ever developed for broadcast use—the Vidicon-type which weighs only two ounces yet promises greater efficiency and economy in the televising of movie films—has been announced by the Tube Department of the RCA Victor Division, Radio Corporation of America.

The new electronic "seeing eye" for TV film cameras is only a fraction of the size of an Iconoscope tube normally used for film pickup, yet it is up to three times more sensitive and has a spectral-response characteristic approaching that of the human eye. The tube (RCA-6326) measures only one inch in diameter and six and one-quarter inches in length.

The new tube, because of its small size and simplicity, makes possible simpler, more compact, lower-cost TV film cameras and associated equipment for broadcast film-pickup. Cameras using this new pickup tube can be used with any type TV-film projector and operate at relatively low voltages.

The new camera tube is an outgrowth of the original Vidicon-type pickup tube for industrial, closed-circuit TV systems announced last year by RCA and also utilizes a photo-conductive layer as its light-sensitive element. The film pickup Vidicon has a resolution capability of approximately 600 lines, and needs only one-third to one-half the light requirements of an Iconoscope for televising motion picture films. For televising transparencies and opaques, the light requirement is only one-twentieth of that needed for film pickup.

# Technical Ramblings

By B. VAN SUTPHIN  
NRI Consultant

## Question: How Does a Condenser Work?

The basic facts of condenser operation can be illustrated with a reasonably large condenser (.1 mfd. or larger) and an ohmmeter. Here is the procedure: Set the ohmmeter to a reasonably high scale, and connect the ohmmeter leads to the condenser. Watch the reaction of the ohmmeter. Note the momentary deflection.

The ohmmeter is basically a battery, a dropping resistor, and a milliammeter all connected in series. Therefore, we can consider the circuit as being like the one shown in Figure 1. The initial movement of the meter definitely indicates that current was flowing in the circuit.

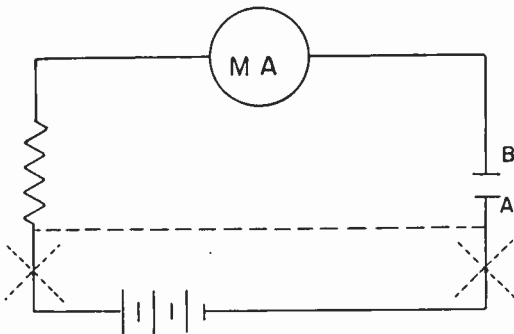

Fig. 1. A simple series circuit which illustrates condenser operation.

When the ohmmeter was first connected to the condenser, electrons moved out of the negative battery terminal and started to pile up on plate A of the condenser. Each time an electron moved to plate A, it exerted a repelling force on an electron on plate B. Therefore, each time an electron moved to plate A, an electron had to move away from plate B. The movement of the large number of electrons caused electron movement in the complete circuit, and consequently the milliammeter indicated current flow.

As electrons moved onto plate A and away from plate B, plate A became negative with respect

to plate B. Therefore, a voltage was built up across the two terminals of the condenser. When the voltage across the condenser equalled the battery voltage, the current stopped flowing because the voltage across the condenser "bucked out" the voltage from the battery. Even though the current stopped flowing in the circuit, a charge still existed across the condenser. Plate A still had more electrons on it than plate B had on it and consequently voltage existed between the two plates. The condenser was "charged."

If you disconnect the condenser from the ohmmeter circuit, it will still retain its charge for a certain length of time. Connecting the charged condenser across the terminals of a milliammeter (as indicated by the dotted lines) will cause the needle of the meter to move, indicating current flow in the circuit. In turn, this indicates that a certain charge must have existed across the condenser. When the source voltage is no longer present, the condenser tries to return to its un-charged state by moving the electrons from plate A around through the circuit to plate B.

This ability to store an electrical charge and release it later makes condensers very valuable in electronic circuits. By using different types of dielectrics in condensers, manufacturers can obtain a wide range of capacity values and voltage ratings.

When air is used as a dielectric, the spacing between the plates must be quite small, or the plates themselves must be quite large in order to obtain reasonably high capacity. Under these conditions, each electron must act across the air gap, and there is considerable loss. By using a solid dielectric—such as mica or ceramic—which places additional electrons between the two plates, the ability to store a charge can be increased. When a solid dielectric is used, an electron on one plate of the condenser acts on an atom in the dielectric, and that atom acts on a nearby atom, and that on a nearby atom, etc. In this manner, a "chain" of movement takes place, and it therefore requires less voltage to

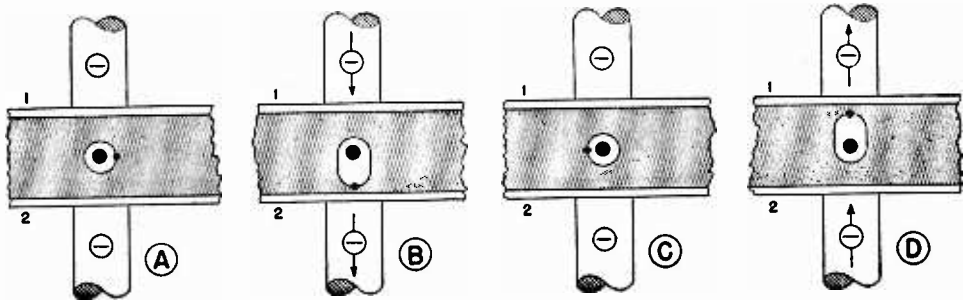

Fig. 2. When an ac voltage is applied across the terminals of a condenser, the "bound" electrons move first one way, then the other, so, in effect, an alternating current flows through the condenser.

cause a certain charge across the condenser. This means that the capacity has been increased.

### How a Condenser Works With AC

So far, we have discussed the action of a condenser when only DC is applied. Actually, the primary use of condensers is in AC circuits, and therefore you must understand the AC action as well. Remember, an AC voltage is one that reverses its polarity periodically. First the voltage tries to move the electrons in one direction; then it reverses and tries to move them in the other direction.

The action of a condenser in an AC circuit is illustrated in Figure 2. When AC is applied, the bound electrons in the dielectric move first one way, then the other, so that the effect is the same as though an alternating current were flowing through the condenser. Figure 2A shows the electrons at rest in the dielectric. When electrons are forced into plate 1, the path of the bound electrons in the dielectric is distorted. This forces electrons out of plate 2 as shown in Figure 2-B. This movement of electrons causes the condenser charge to reach maximum when the AC voltage reaches maximum on that portion of its cycle. As the AC voltage then decreases, the electrons in the dielectric are returned to their normal position as in Figure 2-C. After the AC voltage reaches zero, the direction changes. Electrons are then forced into plate 2, and the electron orbit in the dielectric is distorted in the other direction, as in Figure 2-D. After the voltage has reached maximum in the positive direction, the voltage decreases and the bound electron returns to the position shown in Figure 2A. Then the entire procedure starts over.

From this discussion you can see there is a back-and-forth motion of the electron paths in the dielectric and there is also a back-and-forth motion of free electrons in the conductor. Therefore, there is a back and forth motion of electrons around the complete circuit and you are perfectly justified in saying that an alternating

current passes through a condenser. Actually, the *effect* is transmitted through the condenser but the fact that electrons move in the circuit is the important thing. In AC circuits the distance that an electron moves is relatively unimportant. The important thing is the number of electrons which actually move within a given period of time.

It takes a certain amount of energy to move the bound electrons in the dielectric, and this loss restricts current flow in the circuit. If the condenser is made larger, there are more electrons for the AC voltage to act on, and consequently there is less opposition to AC current flow. This opposition to AC current flow is called *reactance*. Here are two general rules regarding capacitive reactance: The larger the condenser, the less the reactance at a given frequency. As the frequency increases, the reactance of a given size of condenser decreases.

### Summary

Condensers are among the most common parts in radio and television circuits, and a clear understanding of condenser operation is an asset.

These basic rules of condenser operation should prove helpful particularly in studying the action of filter condensers:

(a) A condenser will charge when the voltage across it is increasing. (b) A condenser will discharge when the voltage is decreasing.

The above rules show that a condenser will tend to keep the voltage across it at a reasonably constant value. Can you see how this applies to filter operation? And bypass operation?

Here are two other rules that should prove helpful, particularly in studying coupling condensers:

(a) When the frequency is low, a large value of capacity must be used. (b) When the frequency is high, a smaller condenser will be satisfactory.



# N.R.I. ALUMNI NEWS

Norman Kraft .....	President
F. Earl Oliver .....	Vice Pres.
Oliver B. Hill .....	Vice Pres
Harvey W. Morris .....	Vice Pres
Thomas Hull, Jr. ....	Vice Pres
Louis L. Menne .....	Executive Secretary

## Oliver B. Hill of Burbank, Calif. is President-elect of the NRIAA

Morris of Philadelphia, Oliver of Detroit, Hull of New York and Grossman of New Orleans are Vice Presidents.

The polls are closed. The ballots have been counted and the result shows Mr. Oliver B. Hill of Burbank, California, elected to serve the NRI Alumni Association during the year 1954. Elected with him as Vice Presidents are F. Earl Oliver of Detroit, Harvey Morris of Philadelphia, Thomas Hull, Jr. of New York and Louis E. Grossman of New Orleans. Our President-elect, long a member of the NRI Alumni Association, is the idol of our members in the West. He also had good support from members in the middle West and East. He ran a strong race but not far behind was his opponent, Mr. Floyd Buehler of Detroit, who most certainly has established himself as a man who must be recognized in the not too distant future.

Some old, reliable standard-bearers such as Harvey Morris of Philadelphia and F. Earl

Oliver of Detroit were easily re-elected Vice Presidents. Thomas Hull of New York also was re-elected. A new name in our National Organization is that of Louis E. Grossman of New Orleans who has been elected a Vice President. Mr. Grossman is chairman of our New Orleans Chapter. He is responsible for the development of the fine chapter we have in the Crescent City.

Norman Kraft of Perkasio, Penna., who is a member of Philadelphia-Camden Chapter, will complete his year of office on December 31, 1953. He has been a very good president and under his leadership our Association has again shown substantial gains in our membership. We very much appreciate the good work of our retiring President, Mr. Kraft.

With Mr. Hill at the helm we may expect another excellent year in 1954.

## Chapter Chatter



New Orleans members were invited to visit station WDSU-TV and just about every member of the chapter took advantage of the opportunity. They took buses to the station, then divided into two groups and were guided through the buildings. The groups then re-boarded the buses and were driven to the transmitter where they were again very courteously and patiently escorted through the buildings. Sincere thanks are extended to the officials of WDSU-TV for the splendid way in which they received us.

WJMR-TV is a new UHF station in New Orleans. Mr. George A. Majoral, Executive Vice President and Chief Engineer addressed the members of our chapter at one of our meetings. Mr. James Gordon, Manager of WJMR, also spoke to our members on this occasion. Our members are still talking about these last two meetings. NRI students and graduates in the New Orleans area who are interested in attending meetings please contact Chairman Louis E. Grossman, 2229 Napoleon Ave. in New Orleans.

Chicago Chapter continues to meet at 8 P.M. on the second Wednesday of each month in the American Furniture Mart, 666 Lake Shore Drive. (West entrance.) We have had some good talks on the cathode ray tube, scope, distortion and servicing loudspeakers. Students and graduates in Chicago are cordially invited to meet with us.

Detroit Chapter is having one of its most successful seasons. Vice President Earl Oliver, and former Chairman Bob Mains, are performing a series of demonstrations on the use of the NRI Oscilloscope. Chairman Ken Kacel distributed some interesting literature on Phono-Vision, from Zenith. Mr. Thomas Patterson, one of our members, who is actively engaged in television servicing, delivered a blackboard talk on practical approaches to TV servicing. A great many questions which have been bothering some of our members were answered in this talk.

We have plans for visiting a local Television station and another visit is scheduled to KLA Laboratories to view demonstrations of High Fidelity systems and Public Address systems. The secretary of Detroit Chapter is Mr. Robert M. Kinney, 16565 Cruce St., Detroit.

Philadelphia-Camden Chapter was addressed by Mr. Floyd Myers, Service Manager of the Stuart Lochheim Company, Zenith distributors. His talk was on TV trouble-shooting. Mr. Myers showed the members a number of short cuts in servicing.

Harvey Morris chose as his subject "How to follow a schematic." Harvey has the knack of making everything sound quite simple.

Two new chapter members are Stephen Kut of Sellersville, and Mr. David Kiser of Philadelphia.

A stag party is scheduled for December 14. We meet on the second and fourth Monday of the month at the Knights of Columbus Hall, Tulip and Tyson St. in Philadelphia. Students and graduates in this area are always welcome.

Pittsburgh Chapter is going along in great shape with members who are skilled and experienced in Radio and Television servicing putting on most of the demonstrations. For example, H. A. Tate spoke on Signal Tracing, D. C. Benes and T. D. Schnader spoke on the NRI Scope and the Crosley TV receiver, William Lundy and J. S. Kyler spoke on the Vacuum Tube Voltmeter and Schematic Reading.

Our Executive committee meets regularly to plan meetings in advance. For this reason we always have something good on tap.

Speaking of tap, a stag party is scheduled for Thursday, December 3 to bring our year to a successful close. We expect visitors from Washington on this occasion. Pittsburgh Chapter now has a total of sixty-six regularly enrolled members and commitments from others which could easily bring the membership up to 91. A splendid growth considering the short time the chapter has been in existence. Meetings are held on the first Thursday in each month, 8 P.M., at 134 Market Place. John J. Olejar is secretary.

Baltimore Chapter with Mr. Rathbun and Mr. Shue, always ready with a good talk, are meeting regularly at 745 West Baltimore Street, in Baltimore. These meetings are held on the second Tuesday of each month.

New York Chapter with never less than fifty present and usually considerably more, is giving its members some excellent talks by Mr. Ralph Georg who spoke on Electronic Tubes, Mr. Dave Spitzer who spoke on TV Servicing, Mr. Phil Spampinato who spoke on Trouble Shooting in Automatic Gain Control Circuits, Mr. Thomas Hull, Jr. who conducts our Radio Clinic and Mr. Alex Remer and Mr. Wm. Fox who conduct our Radio and TV forum. With Chairman Bert Wappler, Secretary Lou Kunert and Treasurer Frank Zimmer always on hand things keep on the move in New York.

This chapter meets on the first and third Thursday of each month at St. Marks Community Center, 12 St. Marks Place, between Second and Third Avenues in New York City.



Charter members of Milwaukee Chapter of the NRI Alumni Association at organization meeting held at the Ambassador Hotel on Oct. 29th, 1953.

## Milwaukee Chapter is Organized

A meeting of NRI Alumni Association members was held at the Ambassador Hotel in Milwaukee on October 29. A total of forty-three graduates attended and all joined as charter members of this newest NRIAA chapter. Members were drawn from Milwaukee, Kenosha, Waukesha, Racine and other points adjacent to Milwaukee.

After preliminary remarks by L. L. Menne, Executive Secretary of the NRI Alumni Association, Mr. S. J. Petrich of Petrich Television and Appliance, 5901 W. Vliet Street, was appointed temporary chairman to serve until permanent officers are elected in December. Mr. Elwin Sowle, 1102 South 30th Street, Milwaukee, was appointed temporary secretary. These officers immediately took charge and did an excellent job of getting things organized.

After a brief discussion it was agreed that each charter member would pay \$1 initiation fee to give the chapter some working capital and that the dues would be \$5 a year. This money is to be used for payment of rent on a still to be selected meeting place, for sending meeting

notices to members and for other nominal expenses incidental to the smooth working of a successful chapter.

Mr. Petrich appointed a committee of five to meet at his place of business for the purpose of laying plans to secure a proper meeting hall and to arrange programs for the next several meetings. In addition to Mr. Petrich the members of this committee are Mr. Elwin Sowle, Mr. Walter Haag, Mr. Robert Krauss and Mr. Ernest V. Bettencourt.

As a special feature the gathering was addressed by Mr. David Blackwell, Chief Production Engineer, Zion Division, Warwick Manufacturing Company of Chicago, who spoke on "Visual Alignment." Mr. Blackwell is an NRI graduate who formerly lived in New Jersey and who served several terms as chairman of Philadelphia-Camden Chapter. New opportunities brought him to the middle west. We were pleased to have him with us on this occasion.

Milwaukee Chapter is off to a very good start.



# Here And There Among Alumni Members



Coy G. Riggs, of Memphis, Tenn., tells us that upon finishing his NRI training he was immediately employed in one of Radio's closely related fields, and is now in training as a business manager.

-----n r i-----

Leroy Musselwhite, of Rockingham, N. C., has a new job as Final Production Inspector for the Prosser Co., manufacturers of transmitters and receivers.

-----n r i-----

Graduate Tony Flaminio, of Buffalo, N. Y., is happy with his job as a TV benchman for the Admiral distributors for western New York State.

-----n r i-----

Graduate W. G. Louchridge is employed as a Junior Engineer with the Electronics firm Varion Associates, of Palo Alto, Calif. Says NRI was a big help to him.

-----n r i-----

Pvt. James D. Johnson, of Fort Jackson, S. C., is now assigned to Post Signal Repair (Radio and Telephone), thanks to NRI training. Enjoying Army life much more now.

-----n r i-----

The Management of the Trenton, Mich., Chrysler Plant recently announced the appointment of Floyd A. Buehler as Instructor and Conference Leader of the Educational Division. Floyd is an active member of Detroit NRIAA Chapter and was this year nominated as one of the two candidates for President of NRIAA.

-----n r i-----

Graduate H. E. Saylor, of Washington, D. C., is now an Engineer for a major TV network here in Washington.

-----n r i-----

Grad R. M. Sadler of Clayton, New Mexico, is moving to another location. Has an established business in Radio and TV for sale. Suggest anyone interested write directly to Sadler for details.

-----n r i-----

John Crofford, Jr., of Phoenix, Ariz., now has a full-time job in the only complete auto radio service shop in Phoenix. Crofford is a recent NRI grad and is on his way up in the field of Radio.

-----n r i-----

Glad to hear from our old NRI Graduate Bartolome A. Tuason, of Manila, Philippine Islands. Tuason is at present in Manila as Chief of the Construction and Maintenance Section of Airways Division, CAA, and acting head of Radio Dept., Feati Institute of Technology.

-----n r i-----

C. Wendling, of Detroit, Mich., reports that he is now working as an Electronic Technician. Says pay is excellent, and work is varied and

increasingly interesting

-----n r i-----

Graduate Harvey B. Short of Highland, N. Y., would like to hire an NRI student or graduate to do part time work. Starting in part time work himself, Short's business has grown into full time and is ready for further expansion. Has Philco Dealership.

-----n r i-----

Alumnus Donald Evans, of Winchester, Ohio, is busy with plans to open a new Radio and Television Shop on Main Street in his home town. Good luck, Donald.

-----n r i-----

Graduate Robert E. Chapman, of Waco, Texas, now has amateur call W5BHX.

-----n r i-----

Congratulations to William Kline, of Cincinnati, Ohio, who, after almost fourteen years of part time service, has started a full time servicing business. Says it was hard to break away from his steady job, but he now loves his work. Doing all right financially, too.

-----n r i-----

Nels W. Willason, of Seguin, Texas, has recently returned from a tour overseas as a Philco Field Engineer. Holds a 1st 'phone license, and is interested in making a new contact in Communications Engineering or Research.

-----n r i-----

Graduate James B. Free, formerly of Opp, Ala., is now with the CAA at the Foreign Aeronautical Communications Station in Balboa, Canal Zone.

-----n r i-----

Wilfred Miller, of Lake Charles, La., is now a Radio-TV Repairman for a Sears, Roebuck & Co. store. Also has a good spare time business.

-----n r i-----

Thomas E. Diggs, W6ZTG, of Castro Valley, Calif., is now with Lake Shore Electric Co., a Radio-TV firm in Oakland.

-----n r i-----

Recently received an attractive business card from "Doc" Benson's Radio Hospital, of Umatilla, Oregon, which is owned by Graduate Billy J. Benson, Sr.

-----n r i-----

George Ott, Jr., of Meadville, Penna., who owns Ott's Radio & Television is doing things in a big style. Has four trucks on the road for TV service and installation. Is also doing the installation of drops for a closed circuit TV cable company in Meadville. Employs nine people in the organization. Sells Sylvania TV and handles factory service for this make in his area. An ardent NRI booster.

-----n r i-----

Graduate Olin B. Robinson, of Rome, Georgia, is a District Communications Engineer for the Georgia Forestry Commission. Holds 1st 'phone. Getting ready for General Class Amateur exam.

# NATIONAL RADIO-TV NEWS

16th & U Sts., N.W.

Washington 9, D. C.

Sec. 36.44, P. L. & R.  
U. S. POSTAGE  
**1c PAID**  
Washington, D. C.  
**Permit No. 7052**

Forwarding Postage Guaranteed

For:

Mr. Francis H. Fingado      25236  
611 17th St.  
Denver 2, Colo.

4

POSTMASTER—FORM 3547 REQUESTED

## National **RADIO-TV NEWS**

Vol. 15      Dec.-Jan., 1953-1954      No. 12

Published every other month in the interest of the students  
and Alumni Association of the

**NATIONAL RADIO INSTITUTE**  
Washington 9, D. C.

The Official Organ of the N R I Alumni Association.  
Editorial and Business Office, 16th & You Sts., N. W.,  
Washington 9, D. C.

**L. L. MENNE, EDITOR**  
**H. L. EMERSON, ASSOCIATE EDITOR**  
**J. B. STRAUGHN, TECHNICAL EDITOR**

NATIONAL RADIO-TV NEWS accepts no paid advertising. Articles referring to products of manufacturers, wholesalers, etc., are included for readers' information only, and we assume no responsibility for these companies or their products.

## *Index*

Article	Page
Message from President Eisenhower .....	2
Hum Problems in TV Receivers .....	3
Our Cover Photo .....	6
Using Diagrams in Set Servicing .....	8
NRI Test Instruments and Supplies .....	16
Technical Ramblings .....	26
NRI Alumni Association Election Results ..	28
Chapter Chatter .....	29
Milwaukee Chapter Organized .....	30
Here and There Among Alumni Members .	31

Printed in U.S.A.